

servomold®

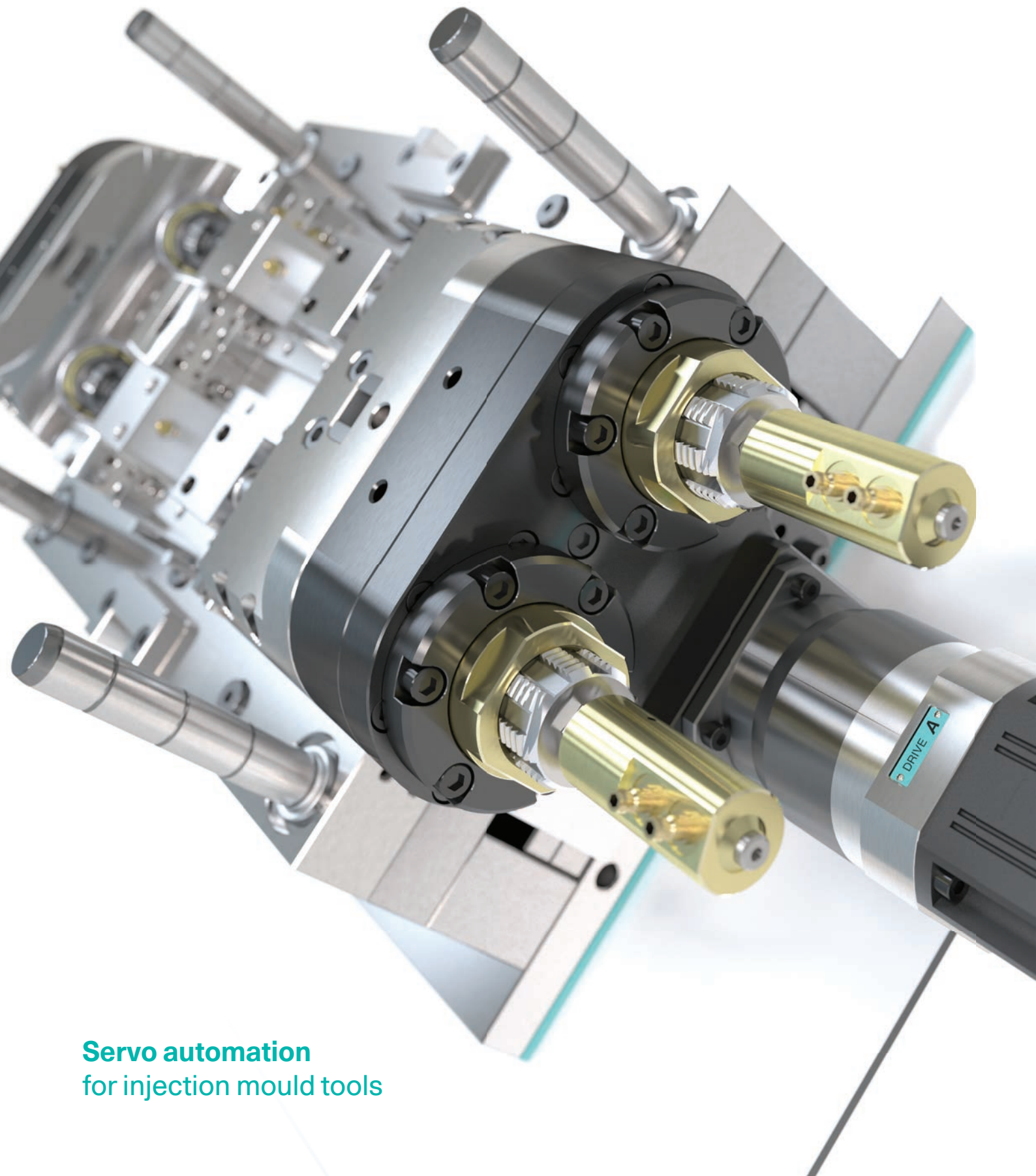

Servo automation
for injection mould tools

The motion

How to get an industry moving

Servo technologies offer countless possibilities, especially for injection mouldmaking, for automating rotational and linear movements precisely and with pinpoint accuracy. Corresponding applications convince with highest process and mould safety and offer significant energy savings compared to hydraulic and pneumatic systems.

To realise this potential, Servomold combines the experience of more than 20 years of moldmaking and automation - and uses the resulting synergies to create a clean and efficient standard for the automation of injection mould tools. As a consultant, designer and supplier, we stand for reliable components specifically adapted to the requirements of injection moulding processes and fully integrated system solutions. This expertise is shown in more than 900 servo systems we have implemented for customers around the world since 2012.



Bianca and Thomas Meister, Management

Servo technology inspires



with every movement

Oil-free, clean, environmentally friendly. Servomold servo technology is the ideal complement.

John Erwes, Erwes Reifenberg



Modern injection mouldmaking has discovered the advantages of servo technology for itself and benefits greatly from the wide range of possible applications. Servo creates the perfect conditions to meet the requirements of global industries for minimum cycle times, highest availability as well as extensive process control and traceability. In addition to aviation, automotive, medical and pharma, these include industries such as fastening and con-

struction, as well as furniture, consumer goods and packaging. Especially when using all-electric injection moulding machines, the desire for oil-free, clean and environmentally friendly solutions is in the foreground - here, servo components are the ideal complement to achieve clean operating conditions and to individually design efficient, high-precision processes.

Process safety and performance

The integration of servo drives in injection mould tools requires indepth knowledge in both mouldmaking and automation. The numerous influencing parameters of both worlds presuppose extensive planning and require the calculation of process forces as well as rotational and inertial torques, taking into account relevant process parameters.

The design and service life calculation of gearboxes, bearing elements and gearing components by software is the reliable base for our designs. Added to this are tolerance analysis, material selection and evaluation, and extensive risk analyses. When designing sophisticated servo systems, we leave nothing to chance - this is precisely where our know-how and strength lie.

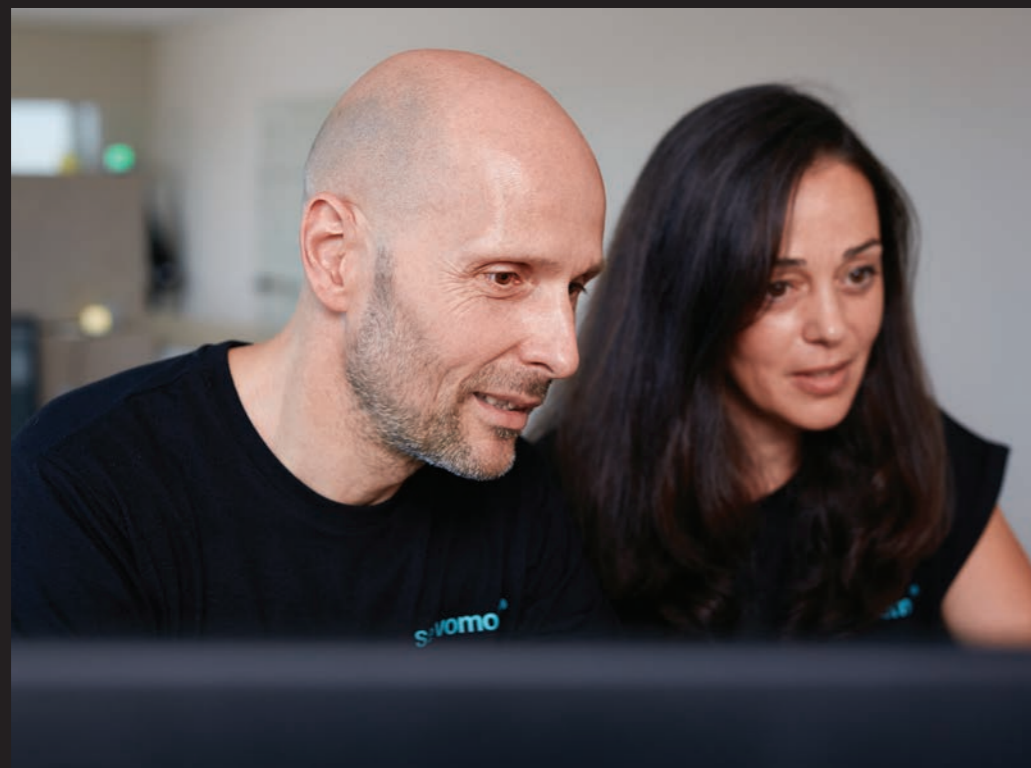

The ability to think out of the box...

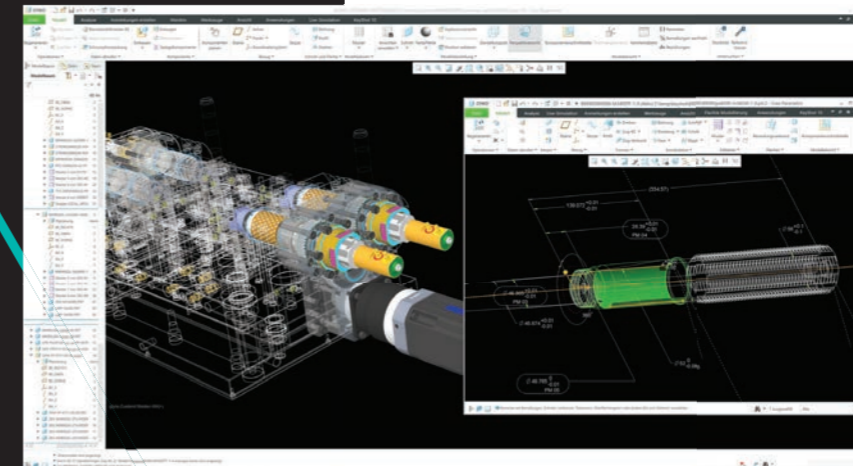

...and yet concentrate on the essentials...

Technical partner with foresight

We are your reliable partner, not a service provider - which is why we keep an eye on the big picture and deal intensively with your mould and the entire process chain. Experienced project managers and design engineers support the cooperation from the beginning as personal contacts and lead your project to a successful completion.

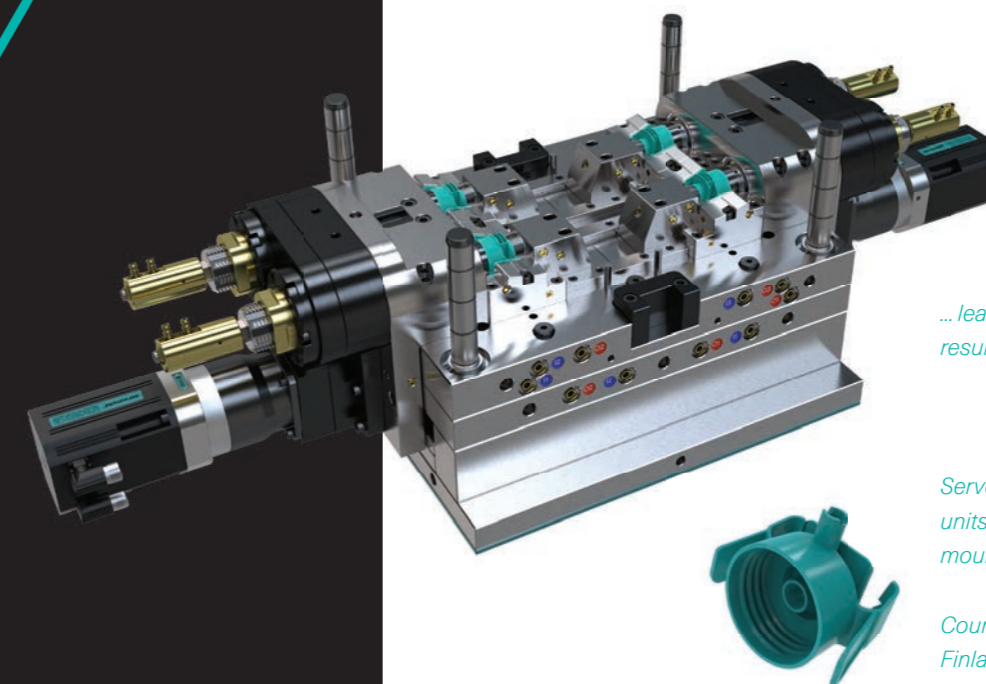

... leads to extraordinary results.

Servomold double unscrewing units on fourfold unscrewing mould

Courtesy of Sartorius Finland.

You set the requirements,

we deliver the complete solution.

› **Customised, standardised**

Rotational and linear movements take place in your injection mould tools, which can be ideally implemented using servo motors. We offer an individual solution for every standard process.

› **Clean, low-maintenance operation**

Servomold systems offer a quiet, durable, and nearly maintenance-free replacement to, for example, hydraulic systems - under cleanroom conditions.

› **Time-saving and pinpoint**

Modern production requires solutions that lose nothing in terms of precision and repeatability with the shortest cycle times. With us, you achieve maximum efficiency.

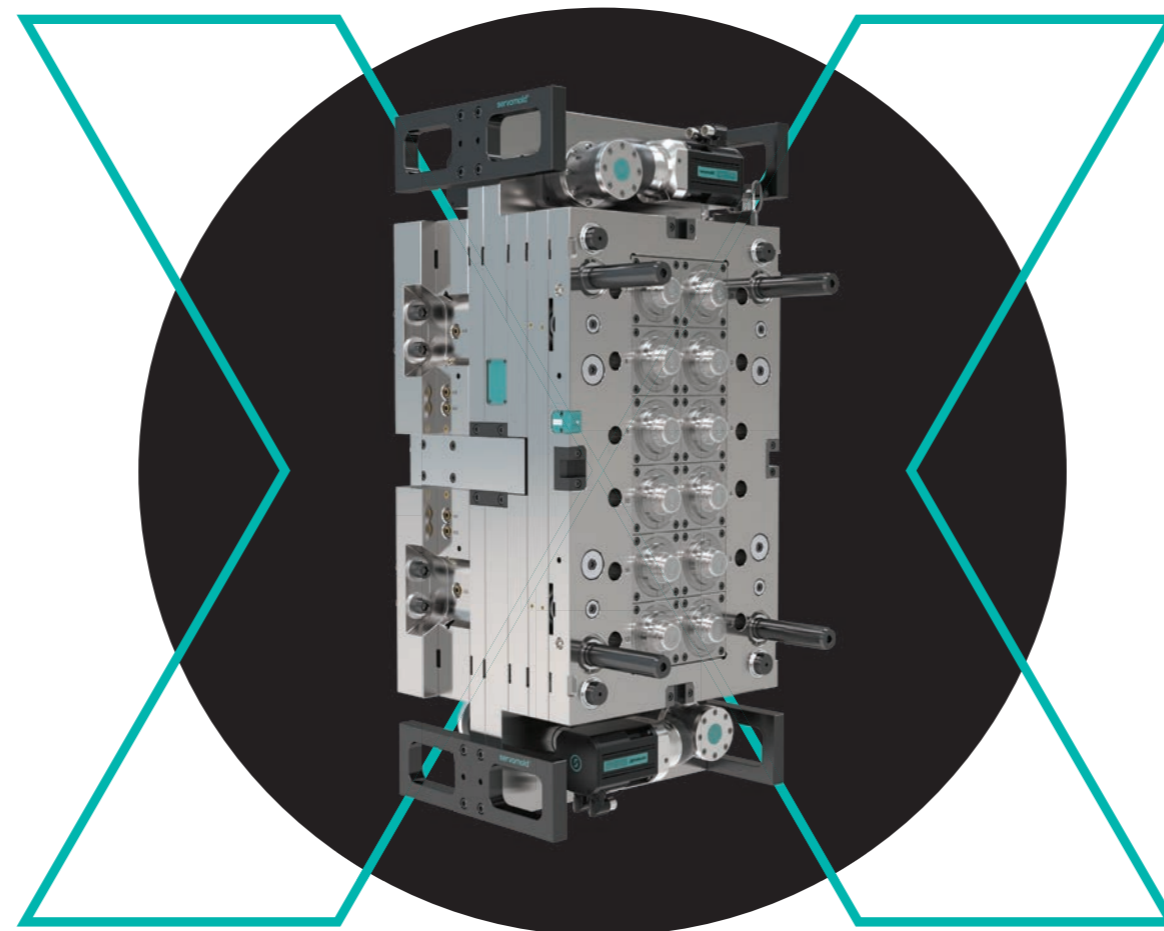

Unscrewing halves

› **Concept, calculation and design**

You tell us your specifications, and together we create a concept that is optimally tailored to your application - including calculation of the longevity and functional guarantee as well as the individual production of the design data.

› **Manufacturing and assembly in-house**

We manufacture your system in-house up to the complete unscrewing half. The production of individual components complements our system of modular standard parts.

› **Ready-to-use system solution**

Servomold systems are delivered ready for installation and fit precisely into your injection mold tools. Configuration and commissioning are done by us on site.

Modular Servomold system components



Threaded core systems

Rotary unit for indexing plates

Unscrewing devices

Drive units

Linear actuators

Function meets intuition



Next
Generation
from mid
2023

Management, monitoring, evaluation and 100 % control at all times.

The SMC panel offers a clear overview of all operating states, oscilloscope functions and simple adjustment of process parameters in live operation on its touchscreen user interface. The configurable RFID user management allows individual adaptation to your safety requirements and simplifies the monitoring of changes and optimisations.

Servo Mould Control

In use in over 900 applications worldwide.

The hardware and software specially developed by Servomold for controlling our servo motors is a compact, standardised all-round system with up to 8-fold servo control. Pre-programmed functions, especially for the requirements of injection moulding companies, can be used for process adjustment.

A unique technology allows the universal and flexible use of different position encoder systems. Interfaces to all common injection moulding machines guarantee smooth integration. All control units are also directive-compliant, CE-tested and equipped with complete safety technology.

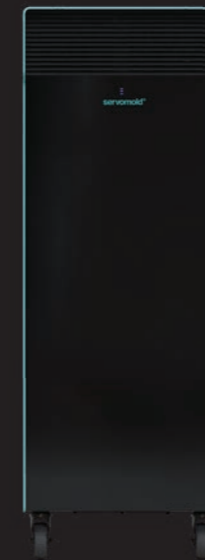

SMC Rack

- Up to 8 drives
- Servo amplifier
20 A / 45 A / 100 A



SMC Standard

- Up to 4 drives
- Servo amplifier
20 A / 45 A / 100 A



SMC Mini

- 1 drive
- Servo amplifier
20 A / 45 A

Ready for your challenge

Extensive technical support for individual adaptations and for integration into your processes is an integral part of our system solutions. Commissioning is carried out by our qualified technicians on site worldwide and supplemented by remote services. With spare parts, maintenance and repair services, we guarantee many years of worry-free operation of our systems and are always available to answer questions by phone and online support.

› Programming and programme adjustments

We create a sequence programme optimised for your project, including coordination with your process sequence during commissioning. The operation of our control unit is made easy by simple parameterisation.

› Telephone and online support

Injection moulding applications are often in operation around the clock. Our support team therefore provides direct and competent assistance in eliminating malfunctions and always answers questions about operation and process optimisation as quickly as possible.

› Commissioning and training

We help to convey and deepen the know-how for the operation of our systems through practice-oriented training. In many cases, this can already take place during commissioning and creates a direct link to practical application.

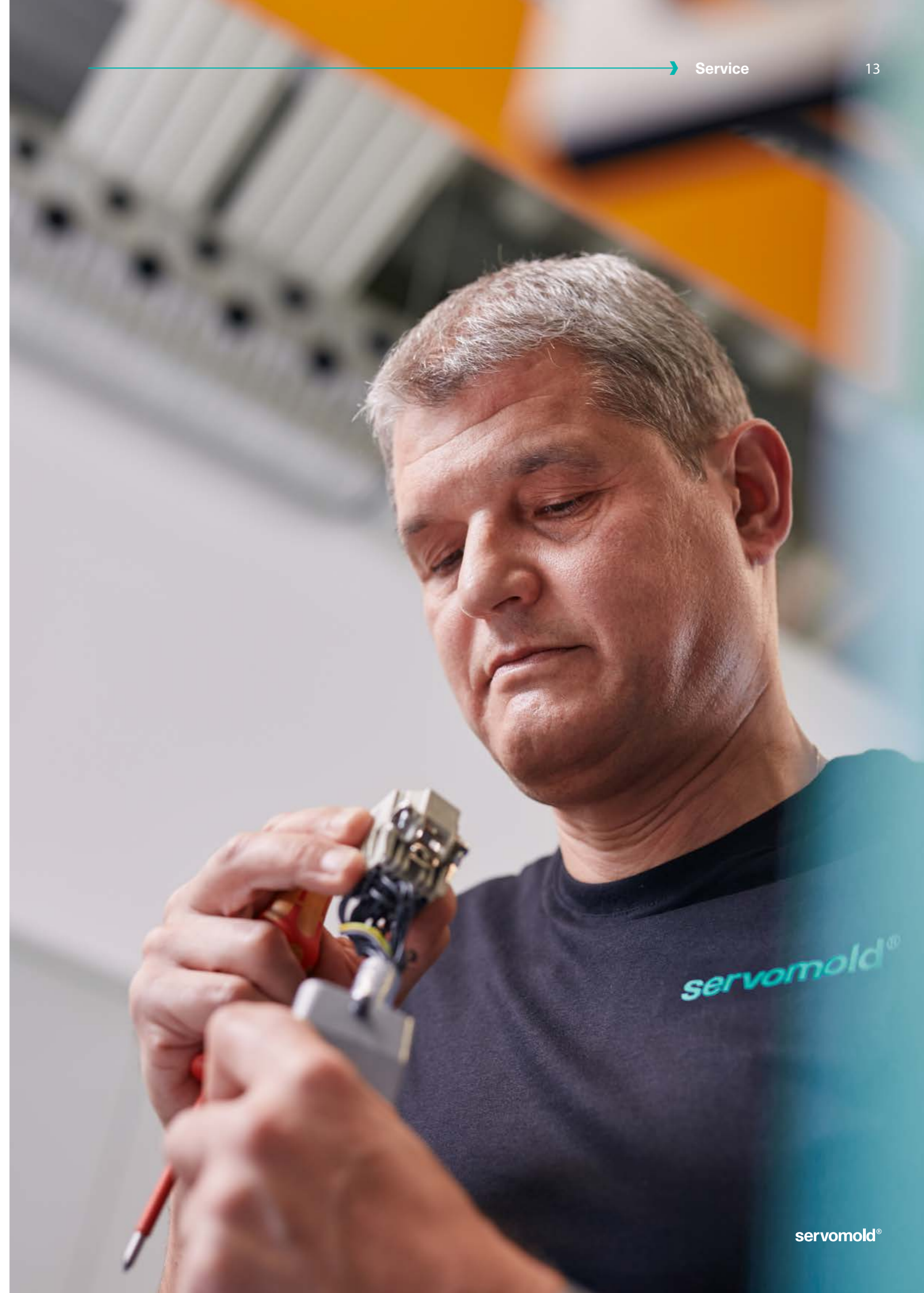

WILD & KÜPFER

» At our state-of-the-art facility in Schmerikon, we continuously invest in cutting-edge technology and top performance - that's why we were early adopters and have relied on Servomold technology since then. «

Daniel Wild, CTO, Wild & Küpfer, Schmerikon – Switzerland



Erwes Reifenberg

» We rely on Servomold know-how, servo drives and control units for our high-performance moulds in the Caps and Closures area - they are the ideal complement to our 45 years of experience in manufacturing injection mould tools. «

John Erwes, CEO, Erwes Reifenberg, Finnentrop



» We are committed to helping our customers increase their production efficiency and implement more sustainable production processes. That is why we have strategically relied on Servomold system components and control units in more than 25 projects since 2014. «

Peter Hess, Management Technology Center, Braunform GmbH, Bahlingen



» With Servomold system components, we realise durable, low-maintenance and highly efficient moulds. In addition, the professional support of a highly motivated team - for us the main reasons for the long-standing, cooperative partnership. «

Volker Kiene, Teamlead Project Management Industrialization Molds, Aptar Radolfzell



» The key factors for us are the ease of operation, safety and individual adaptability of the Servomold control units to our processes. With a unique technology and extensive support, Servomold offers a currently state-of-the-art concept for the use of servo motors in injection mould tools. «

Thomas Rübsam, Senior Director Technology, Plant Manager Mihla Competence Center Injection Molding, Pharmaceuticals and Devices Division, Fresenius Kabi

Röchling

» For us, Servomold is the de facto standard in the servo automation of injection mold tools. Maximum production reliability and performance, sophisticated technology and outstanding service speak for themselves. «

Christopher Heyd, Manager Tool Shop, Röchling Medical, Brensbach

for creation.



Distribution



Unit H, 100 Shaw Road
(Off Daltry Street), Oldham
Lancashire, OL1 4AB

T +44 (0) 161 678 7090
E sales@cytec-uk.com
W www.cytecsystems-uk.com

Servomold GmbH & Co. KG
Gewerbepark Gräsig 72
64711 Erbach | Germany



T +49 (0) 6062 80933-0
E info@servomold.com
W www.servomold.com